

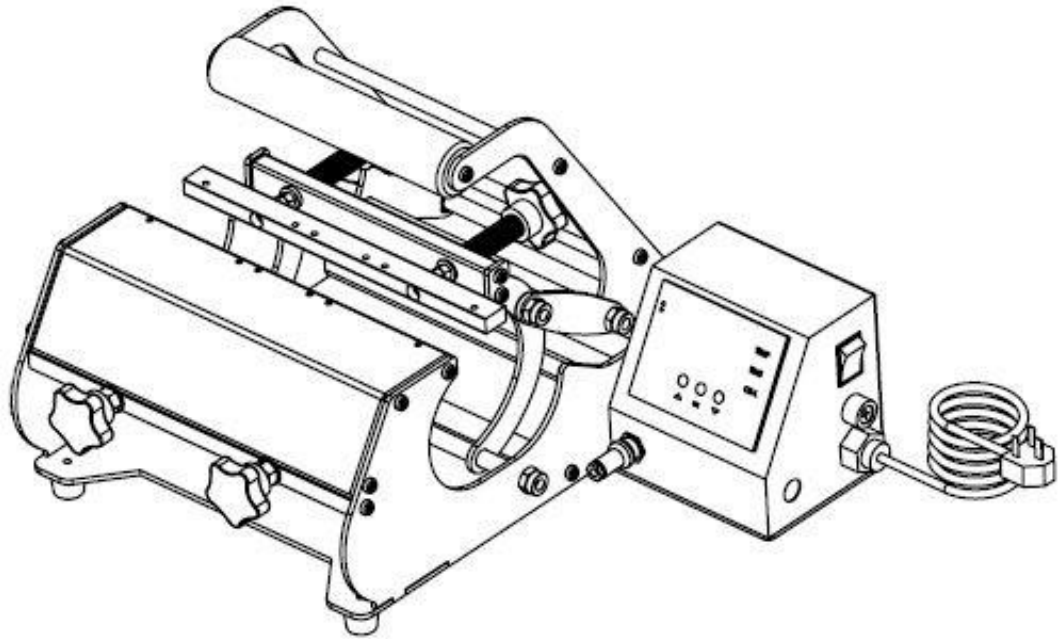

Tumbler Mug Press

Model No.: HPD.TMP600



CONTENTS.

I.	Assembly Drawing	2
II.	Technical Parameters	2
III.	Operating Process	3-5
IV.	Maintenance	6-7
V.	Trouble Shooting For Transfer Print Quality	8
VI.	Heating Element Temperature Measurement	9
VII.	Electrical Diagram	10
VIII.	Exploded Diagram	11-12
	Declaration of Conformity	13

I. Assembly Drawing.

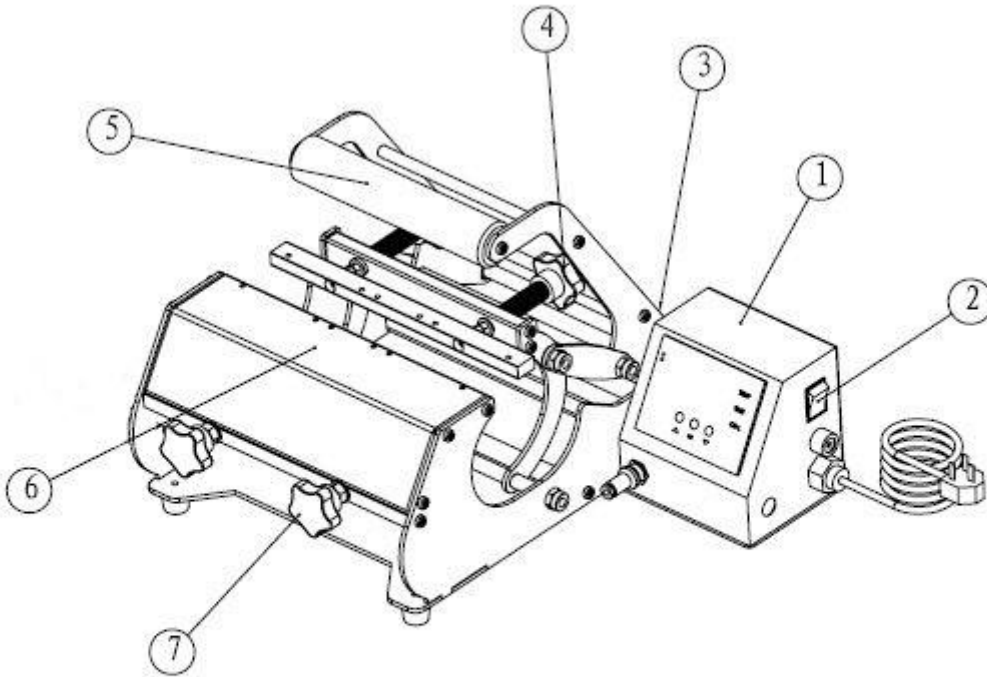









- | | | | |
|-----------------------|----------------------|-----------------|-----------------------------|
| 1) Digital controller | 2) Power switch | 3) Limit switch | 4) Pressure regulating knob |
| 5) Machine handle | 6) Mug element cover | 7) Cover knob | |

II. Technical Parameters.









1. Model No.: HPD.TMP600
2. Machine Dimension: 57 cm (w) x 42.8 cm (d) x 38 cm (h)
3. Machine Dimensions (Export Packed): 58 cm (w) x 51 cm (d) x 37 cm (h)
4. Net Weight: 11.6 Kg
5. Gross Weight: 14.7 Kg
6. Max. Heater Element Size: 220 mm x 205 mm (for 2 pcs. 11oz - 15oz mugs)
7. Voltage: 220V/ 1Phase
8. Power: 0.3 KW
9. Recommended Settings: 30 - 280sec @ 180 - 200°C
10. Time Range: 0 - 999s
11. Maximum Temp: 225°C

III. Operating Process.

1. Set temperature required.

		
<p>Turn on power switch, temperature light is ON. The digital display shows .</p>	<p>Press  button, the  light is on (C denotes Celsius). Press arrows '△' or '▽' to select '°C' or '°F' (F denotes Fahrenheit) according to your habits.</p>	<p>Press  button, the temp  light is on. Using the arrows select the temperature, according to different transfer material (Normally 180°C ~200°C)</p>

2. Set time required

		
<p>Press  button after temperature setting and the  time light is on. Using the arrows select the time according to different transfer material.</p>	<p>Press  button after time setting; the display shows the temperature starts to rise. "CD-L" shows the time counting down during your transfer.</p>	<p>If there is a difference between the actual temperature and temperature shows on the controller, you can use P5 mode to calibrate the difference. For example, when the actual heat platen temperature is 180°C but the display shows 200°C, press  button for 5 seconds to enter P5 mode. When you enter P5 mode, press "△" to set to 20, and then press and hold the  button again for 5 seconds to</p>

		<p>return to operational mode. Likewise, when the actual heat platen temperature is 200°C but the display shows 180°C, press “▽” to set to 20, and then press the “OK” button again for 5 seconds return to operational mode.</p>
--	--	-----------------------------------------------------------------------------------------------------------------------------------------------------------------------------------------------------------------------------------

3. Printing methods.

Step 1:

Insert a blank mug of the required size and shape and adjust the heating element's pressure.

Step 2:

Make sure the cord is connected firmly to the wall socket and turn on the power, using the power switch, located on the side of the control box.

Step 3:

Set the temperature and time required.

Step 4:

Once the temperature is achieved the buzzer will sound. Select a mug that is the correct size and shape for the heating element and secure the transfer paper, with the image side facing the mug, using heat resistant tape; Place the mug into the pre-heated element.

Step 5:

Lower the machine handle to start to the transfer cycle.

Step 6:

Once the counter reaches zero the buzzer will sound again and the mug can be removed from the heating element and the transfer paper removed.

Step 7:

Once the counter reaches zero the buzzer will sound again and the mug can be removed from the heating element and the transfer paper removed.

WARNING:

The mug and heating element will be extremely hot and care must be taken to avoid burn injuries.

4. Recommendations:

1) Ceramic Mug transfer: (These settings are dependent on transfer paper, ink and mug type used and should be used for guidance only)

- Set temperature: 200°C.
- Set time: 240 seconds.

PLEASE NOTE:

- 1) Switch off the machine and unplug the power cord when the machine is not in use.
- 2) The heating element will cool down to room temperature if the heat press stays unused for more than 30 minutes.
- 3) For better maintenance of your heat press the maximum setting temperature is 225°C (437°F).
- 4) To avoid damage to the heating element a blank mug of the correct size and shape should be inserted when the machine is left with the power on.

IV. Maintenance.

1. The machine will not work after you turn on the power.

- 1). Check the plug is connected well or that it is not broken.
- 2). Check the power switch or digital controller is not broken.
- 3). Check the fuse is not blown.

2. Indicating light is on, but there is no display on screen.

- 1). Check the 5 cables of the railway transformer. If it is loose, this indicates that the problem is a poor connection. If it is securely connected, it indicates that the Transformer is faulty.

2. The display screen is working well, but the heating element temperature does not rise.

- 1). Check whether the thermocouple of the heating element is secure. If the thermocouple is loose, the display will show 255°C and the machine will keep beeping.
- 2). Check if the indicating light of the solid-state relay is on. If not, check if the relay or digital controller is broken.
- 3). If you have already replaced the solid-state relay for a new one but the heating element will still not heat up, then check to see if the heating element is faulty or the heating element's power cable is loose, you may need a new heating element.

3. The heat platen works well, but suddenly the display screen shows 255°C.

- 1). Check whether the thermocouple is secure.
- 2). If the thermocouple is firmly attached but the controller still shows 255°C, then it is faulty.

4. The machine is heating between 0~180°C, but the display number jumps to above 200°C or 300°C suddenly, or the numbers on the display jump irregularly.

- 1). Check whether the thermocouple of the heating element is firmly attached.
- 2). If the thermocouple is OK, It shows that the program of the digital controller is broken. You will need to replace it for a new controller.

5. The temperature is out of control: Set to 180°C , but the actual temperature is above 200°C.

- 1). This indicates that the solid-state relay is broken/ out-of-control; You will need to replace the relay.
- 2). Alternatively the digital controller could be faulty with an open circuit providing constant power; You will need to replace the controller.

6. The setting temp and time becomes abnormal after you have replaced the heat platen.

- 1). Please reset the temp and time according to this operators' manual.

7. Maintenance.

- 1). In order to prolong the machine's service life, you should regularly lubricate all mechanical joints with light machine oil.
- 2). Care should be taken to protect the heat platen whenever the machine is not in use. This will prolong the life of the platen and help to keep the image quality of your work high.
- 3). The machine should be stored in a dry place.
- 4) Replace the heating element after approximately 700 transfer cycles or after approximately 2,000 transfer cycles if using a 'Grade A' heating element.
- 5) The following checks should be carried out at regular intervals by a qualified and competent person:-
 - Electrical connections
 - Mechanical moving parts
- 6). If you are not able to solve your problem, please contact heatpressesdirect.com for technical support.

V. Trouble shooting for transfer print quality.

1. If the print colours are pale: the temperature is too low / the pressure is not correct / or the transfer has not been pressed for long enough.
2. If the print colour is too brown or the transfer paper is almost burnt: reduce the setting temperature.
3. If the print is blurring: too much transfer time causes proliferation of the ink.
4. If print colour is different/ partial transfer effect is not good enough: the pressure is not enough / or the transfer has not been pressed for long enough / or poor quality transfer paper.
5. If transfer paper sticks to the object after transfer: the temperature is set too high/ or poor quality printing ink.

VI. Heating Element Temperature Measurement

Testing of the Heating Element for temperature consistency or fault condition should only be undertaken after consulting a qualified engineer, and then only using a wired Digital Thermometer (***please see note below**).



***Please Note:**

The Digital Thermometer with external probe is suitable for surface, air and immersion/penetration measurement, which is required for all Heat Presses Diect heat presses.

Laser Thermometers only measure air surfaces which can be misleading due to currents of hot air floating on the surface of the heating Element.

VII. Electrical Diagram.

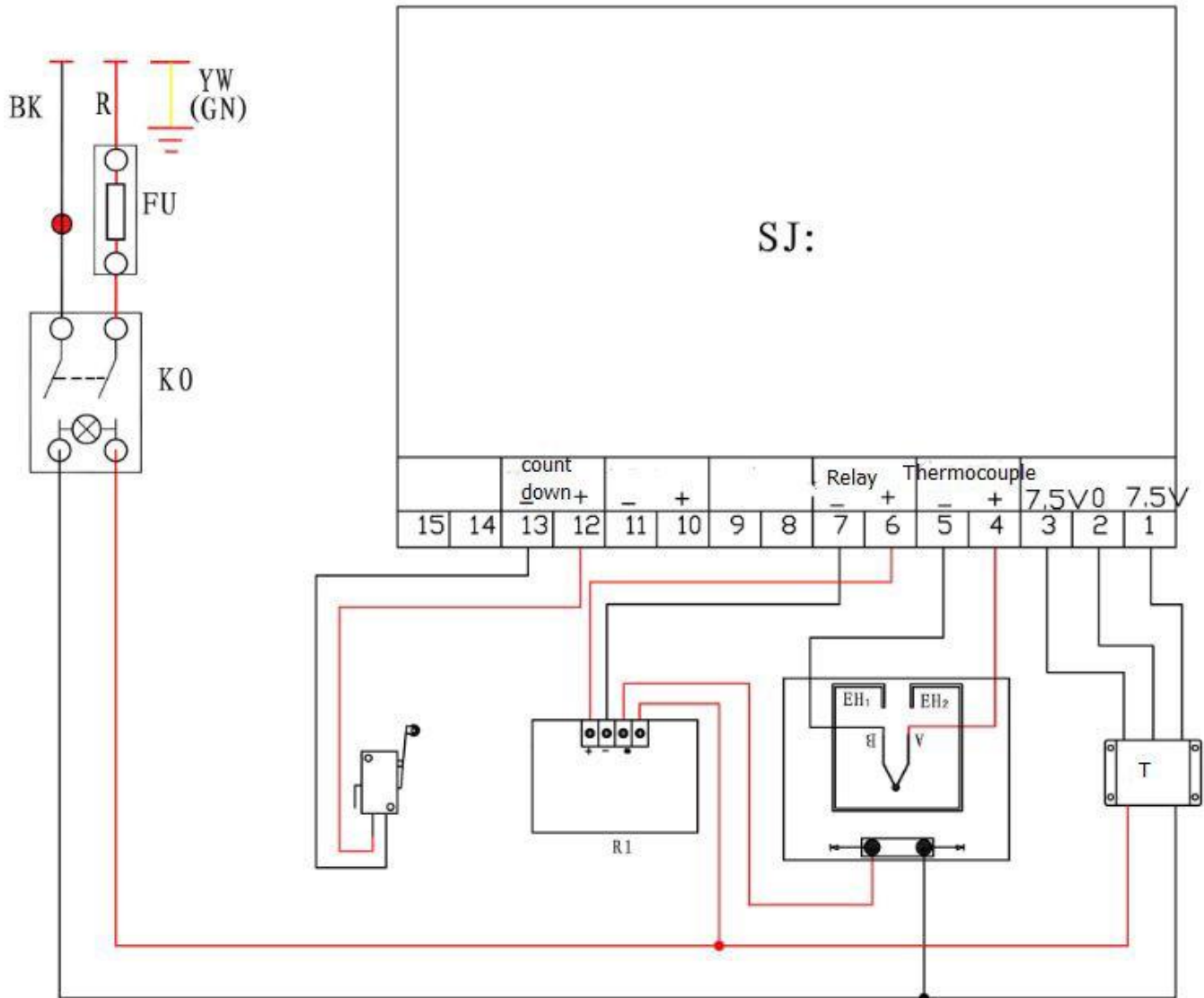

Key:

K0: Power Switch FU: Fuse T: Transformer
 EH1 EH2: Heating Pipe SJ: Digital Controller R1: Relay

VIII. Exploded Diagram.

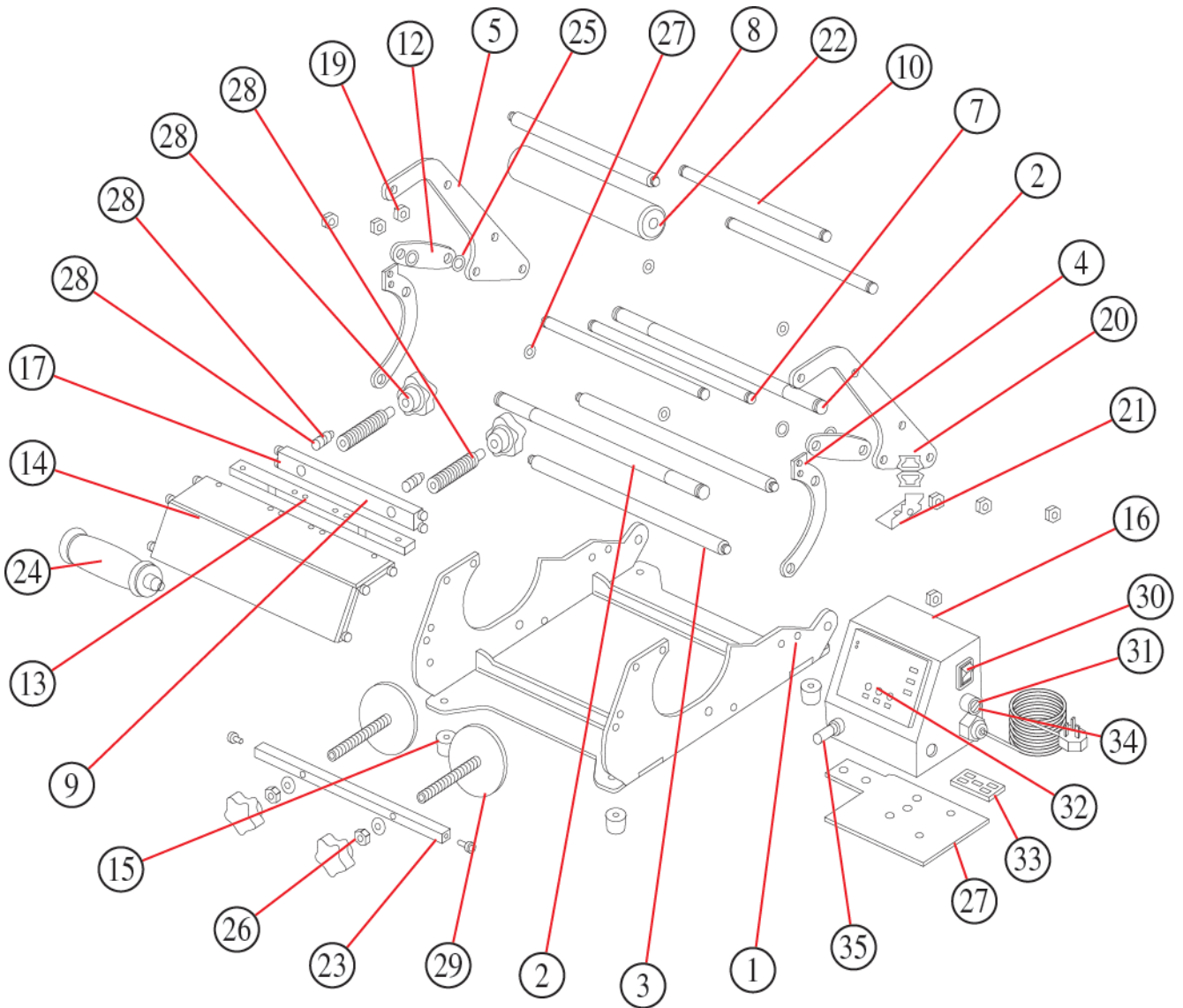

Serial No.	Part Name	Qty.
1	Base frame	1
2	Iron bar	2
3	Limiting rod	5
4	Semicircle frame	1
5	Handle frame	1
6	Handle frame	1

7	Middle pin	1
8	Handle	1
9	Fixed stay	1
10	Support bar	1
11	Handle pin	1
12	Connection strap	1

13	Front pin	1
14	Support plate	1
15	Rubber foot	2
16	Electrical case	1
17	GB-HEXAGON-TYPE21-M6X16-16-N	4
18	GB-HEXAGON-TYPE21-M6X10-10-N	1
19	GB-HEXAGON-TYPE9-M10-N	12
20	Magnetic switch	1
21	Magnetic switch cover	1
22	Handle cover	4
23	Installation panel	1
24	Handle	1

25	GB-FASTENER-WASHER-SMWC-10	1
26	GB-FASTENER-NUT-SNAB1-M10-N	1
27	GB-CONNECTING-PIECE-RING-RRA12	
28	Pressure adjusting kit	
29	Element pins	2
30	Switch - STEZA/22	1
31	Fuse holder - ASCL/36	1
32	Controller – STEZA/16	1
33	TRIAC board – MP300/RELAY	1
34	Fuse 15A 29 mm long - ASCL/37	1
35	Connector	1