

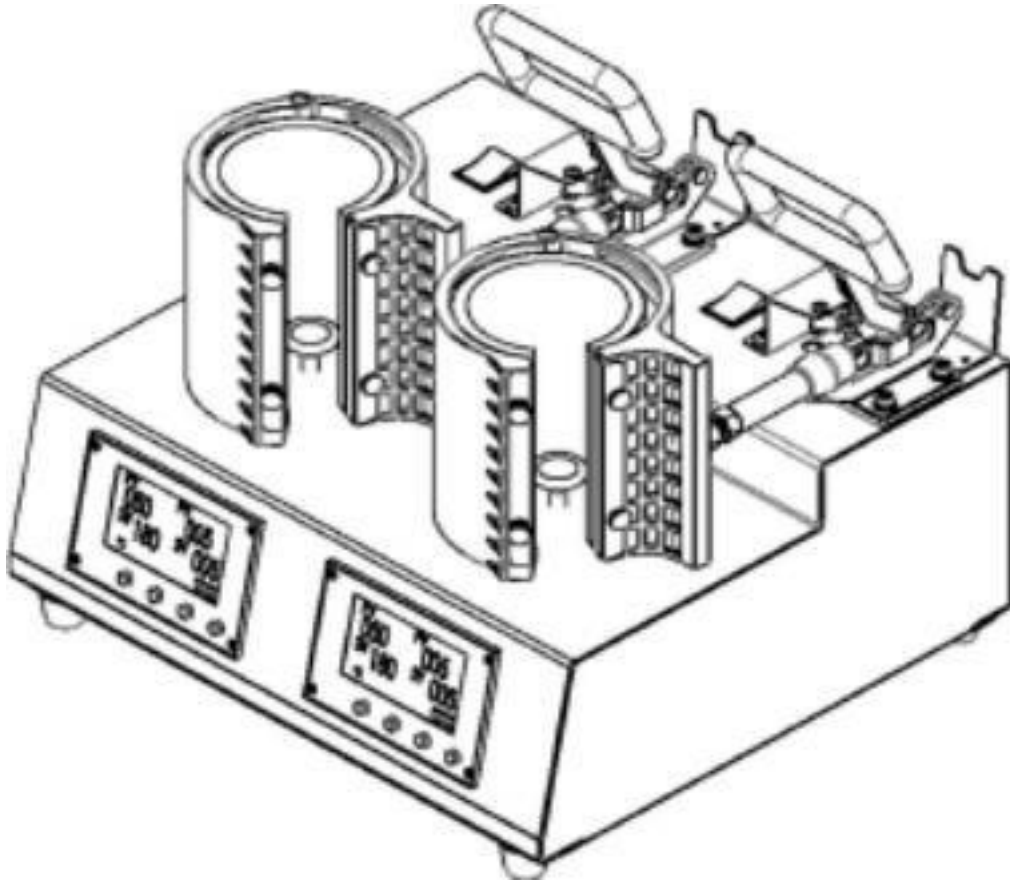

xpres[®]

**Twin Mug Press Model
No.: HPD.TWMP**



CONTENTS

I. Assembly Drawings	2
II. Technical Parameters	2
III. Operating Process	3-4
IV. Maintenance	5-6
V. Trouble Shooting For Transfer Print Quality	7
VI. Heating Element Temperature Measurement	8
VII. Electrical Diagram	9
Declaration of Conformity	10

I. Assembly Drawings

- 1). Digital Controller 2). Individual Power Switch 3). Mug Heat Element 4). Handle limit
5). Limit Switch 6). Handle

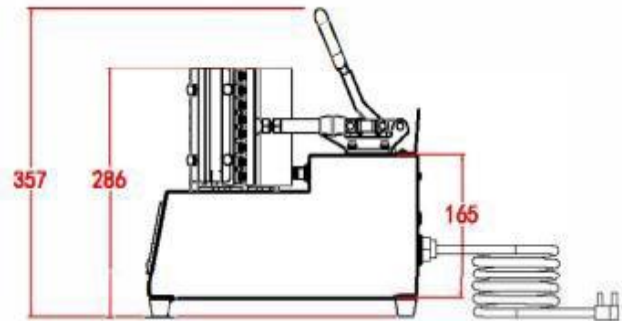
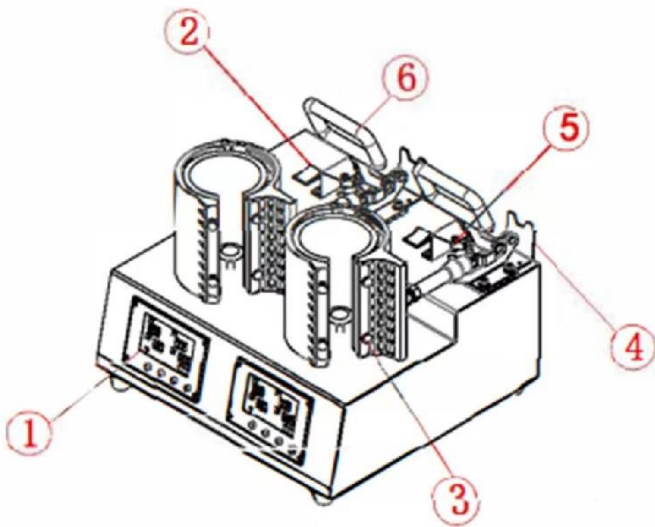







II. Technical Parameters

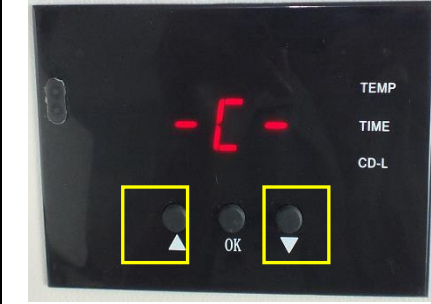





1. Model No.: MPA-200A (x2) Individual Digital Temps & (x2) Timers
2. Machine Dimension: 380*350*357mm
3. Mug Heater Size: Transfer size - 82mm x 120mm porcelain mug / space mug
Transfer size - 72mm x 120mm porcelain mug / space mug
4. Printable Articles Max. Size: Dia. 072/082 mm x 120mm
5. Voltage: 220V Single Phase
6. Power: (x2) 300W = 600W (Total)
7. Recommend Setting: 120~220 s; 180~200 °C
Time Range: 0~450 s
Maximum Temp: 225°C

III. Operating Process

1. Set temperature required.

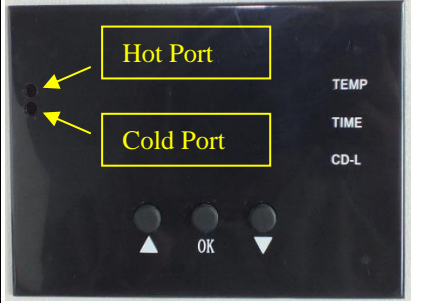
		
<p>Turn on power switch, temperature light is ON. The digital display shows </p>	<p>Press  button, the  light is on (C denotes Celsius). Press arrows '△' or '▽' to select '°C' or '°F' (F denotes Fahrenheit) according to your habits.</p>	<p>Press  button, the temp  light is on. Using the arrows select the temperature, according to different transfer material (Normally 180°C~200°C)</p>

2. Set time required

		
<p>Press  button after temperature setting and the  time light is on. Using the arrows select the time according to different transfer material.</p>	<p>Press  button after time setting; the display shows the temperature starts to rise. "CD-L" shows the time counting down during your transfer.</p>	<p>Note: There are two small ports in the front side of the digital display. If the real temperature is lower than digital controller shown, you can adjust the "hot port"; Clockwise to Raise the temperature; anticlockwise to reduce the temperature.</p>

NOTE: If 'LO' appears on the display, this is part of the program. Once the temperature rises to approx. 100°C the display will change from 'LO' to the actual temperature.

3. Printing methods.

- Step 1: Make sure the cord is connected firmly to the wall socket. Place the Mug in the heating element and then put transfer paper, with image facing down, onto the Mug. Adjust the pressure to your requirement, and turn on the power. P.S: Use heat resistant tape to fix the transfer paper, making sure the transfer paper is securely attached to the Mug and is in the correct position.
- Step 2: Set the temperature and time required (see above) and the temperature will start to rise.
- Step 3: When the temperature has risen to the setting required, the buzzer will sound; you can then close the heating element, (in the meantime the buzzer will stop). This starts the transfer cycle.
- Step 4: When the timer has counted down to zero, remove the Mug from the heating element and peel transfer.

4. Recommendations:

Ceramic Mug transfer: (These settings are dependent on transfer paper, ink and mug type used and should be used for guidance only)

- Set temperature: 200°C.
- Set time: 240 seconds. Note: if you want to transfer 2 mugs at one time, pls set the time and temperature separately for each mug heater.

5. Recommendations:

Ceramic Mug transfer:

Set temperature: 180°C.

Set time: 150 seconds

NOTE:

- 1) Please switch off the machine and unplug the power cord when the machine is not in use.
- 2) The heater will cool down to the room temperature, if heat press stays un-use for more than 30 minutes.
- 3) For better maintenance of mug heat press, the maximum setting temperature is 210°C (410°F).

IV. Maintenance

1. The machine will not work after you turn on the power.

- 1). Check the plug is connected well or that it is not broken.
- 2). Check the power switch or digital controller is not broken.
- 3). Check the fuse is not blown.
- 4). Indicating light is on, but no display on screen, check the 5 cable of Railway transformer. If it is loose, this indicates that the problem is poor connection. If it is securely connected, it indicates that the Transformer is faulty.

2. The display screen is working well, but the heat platen temperature does not rise.

- 1). Check whether the thermocouple of the heating element is secure. If the thermocouple is loose, the display will show 255°C and the machine will keep beeping.
- 2). Check if the indicating light of the solid-state relay is on. If not, check if the relay or digital controller is broken.
- 3). If you have already replaced the solid-state relay for a new one but the heating element will still not heat up, then check to see if the heat platen is faulty or the heating elements power cable is loose, you may need a new heating element.

3. The heating element works well, but suddenly the display screen shows 255°C.

- 1). Check whether the thermocouple is secure.
- 2). If the thermocouple is firmly attached but the controller still shows 255°C, then it is faulty.

4. The machine is heating between 0~180°C, but the display number jumps to above 200°C or 300°C suddenly, or the numbers on the display jump irregularly.

- 1). Check whether the thermocouple of the heating element is firmly attached.
- 2). If the thermocouple is OK, It shows that the program of the digital controller is broken. You will need to replace it for a new controller.

5. The temperature is out of control: Set to 180°C , but the actual temperature is above 200°C.

- 1). This indicates that the solid-state relay is broken/ out-of-control; You will need to replace the relay.
- 2). Alternatively the digital controller could be faulty with an open circuit providing constant power; You will need to replace the controller.

6. The setting temp and time becomes abnormal after you have replaced the heating element.

- 1). Please reset the temp and time according to this operators' manual.

7. Maintenance.

- 1). In order to prolong the machine's service life, you should regularly lubricate all mechanical joints with light machine oil.
- 2). Care should be taken to protect the heating element whenever the machine is not in use. This will prolong the life of the element and help to keep the image quality of your work high.
- 3). The machine should be stored in a dry place.
- 4). The heating element is a consumable part and as such will need to be replace after approx. 700 transfer cycles. Replacement heating elements are available to purchase from heatpressesdirect.com that will allow approx. 2000 transfer cycles.
- 5). If you are not able to solve your problem, please contact heatpressesdirect.com for technical support.

8. The following checks should be carried out at regular intervals by a qualified and competent person:-

- Electrical connections
- Mechanical moving parts

V. Trouble shooting for transfer print quality.

1. If the print colours are pale: the temperature is too low / the pressure is not correct / or the transfer has not been pressed for long enough.
2. If the print colour is too brown or the transfer paper is almost burnt: reduce the setting temperature.
3. If the print is blurring: too much transfer time causes proliferation of the ink.
4. If print colour is different/ partial transfer effect is not good enough: the pressure is not enough / or the transfer has not been pressed for long enough / or poor quality transfer paper.

VI. Heating Element Temperature Measurement

Testing of the Heating Element for temperature consistency or fault condition should only be undertaken after consulting a qualified engineer, and then only using a wired Digital Thermometer (***please see note below**).



***Please Note:**

The Digital Thermometer with external probe is suitable for surface, air and immersion/penetration measurement, which is required for all Heat Presses Diect heat presses.

Laser Thermometers only measure air surfaces which can be misleading due to currents of hot air floating on the surface of the heating Element.

Ink transfer paper sticks to the Mug after transfer: the temperature is set too high/ or poor quality printing

VII. Electrical Diagram

